

FINE PARTICLES CONTENT IN DUST CREATED IN CNC MILLING OF SELECTED WOOD COMPOSITES

Tomasz Rogoziński

Assistant Professor
Department of Furniture Design
Poznań University of Life Sciences
Poznań, Poland
E-mail: trogoz@up.poznan.pl

*Jacek Wilkowski**

Assistant Professor
E-mail: jacek_wilkowski@sggw.pl

Jarosław Górski

Professor
E-mail: jaroslaw_gorski@sggw.pl

Karol Szymanowski

Assistant Professor
E-mail: karol_szymanowski@sggw.pl

Piotr Podziewski

Assistant Professor
E-mail: piotr_podziewski@sggw.pl

Paweł Czarniak

Assistant Professor
Department of Mechanical Processing of Wood
Warsaw University of Life Sciences–SGGW
Warsaw, Poland
E-mail: pawel_czarniak@sggw.pl

(Received April 2017)

Abstract. This paper presents the results of particle-size distribution of dust created in the milling of selected wood composites, which was carried out using a computer numerical control (CNC) machine. The particle-size distribution was studied through the sieving method and the laser diffraction analysis method. The results of the sieve analysis presented general information about the particle-size distribution of the dust, and the results of laser analysis revealed the content of the finest particles in the whole mass of dust created. The particle size of the dust is subject to the influence of the type of wood composite and the fragmentation degree of wood from which the composites are made. The dust created in milling of fibreboards is characterized by the highest content of the finest particles. It is also 2-3 times higher than in dust from drilling.

Keywords: CNC woodworking machine, milling, particle-size distribution, wood composites, wood dust.

INTRODUCTION

Manufacturing of products made of wood and wood-based materials is inseparably connected

with mechanical processing. As a result of technological processes related to the machining of wood materials small waste particles, generally called chips, are formed. The size of formed chips varies depending on the processing method, cutting parameters, and material characteristics. Unfortunately, the whole mass of chips contains

* Corresponding author

† SWST member

very fine particles, which have the ability to disperse in the air (Beljo-Lučić et al 2011; Fujimoto et al 2011; Kauppinen et al 2006). This causes the contamination of work positions and consequently may be harmful to workers' health. To reduce health risks, processing parameters that cause the formation of large amounts of dust should be avoided. It is possible, by technical analysis of the conditions that are favorable to creation of the finest particles, to systematize the factors that lead to reduced dust generation. The effect of some processing parameters such as chip thickness, feed speed, performance of sandpaper, etc. on the creation of wood dust have been studied by others (Dzurenda et al 2010; Kos et al 2004; Mračková et al 2015; Očkajová et al 2010).

Furniture manufacturing is characterized by a high degree of customization and personalization of products that are made from individual customer orders. This causes considerable discretization of technological operations carried out on the machining positions. A variety of materials is used, not just solid wood and typical wood-based materials but also other panels made of wood composites, eg, honeycomb panels. Processing of these materials is often required for the manufacture of complex shaped parts in a reproducible manner (Prekrat et al 2009). Nesting technology based on CNC machines, where the main treatment method is milling, is used for this purpose. The technology is very efficient, but the use of CNC machines results in an increased risk of air dustiness. The conditions under which the chips are created in these machines are very unfavorable from the point of view of the effectiveness of extraction due to the shape and size of the formation zone of chips (Pałubicki and Rogoziński 2016; Rautio et al 2007; Varga et al 2006). Therefore, research and studies aimed at quantitative and qualitative description of the phenomena associated with the formation of chips and especially fine dust that could constitute a potential threat to the health of workers are necessary.

The aim of this study was to determine the particle-size distribution of dust generated during

the milling of wood composites, as well as to determine the fraction of the smallest particles, which are potentially respirable. Moreover, the obtained results will be compared with the results of a previous study on particle-size distribution of dust created in drilling of the same types of wood composites.

MATERIALS AND METHODS

Selection of Wood Composites

Similarly as in the work of Rogoziński et al (2015) wood composites for tests were selected from three groups depending on the fragmentation degree of the wood from which they are made:

Layered materials made most often of veneers and blockboards with cores of wood slats,
Composites made of chips or wood particles,
Composites made of defibrated wood (wood fibers).

Several different composites available on the Polish market of wood materials with different properties and technical purposes were selected from each of these groups to be sampled. The samples were made from the recently purchased, never used boards. The moisture of the samples was 8%. Other properties of composites used in the experiment were characterized by their density. The selected wood composites are presented in Table 1. The letters are assigned to each type of composite to simplify the descriptions in the figures depicting the results and to compare them with the results presented by Rogoziński et al (2015).

Experimental Machining

Experimental machining was carried out using a Busellato Jet-130 (Italy) which is a standard CNC machine that was also used in the experiments by Rogoziński et al (2015). It was equipped with a vertical spindle with a motor power of 7.5 kW and an adjustable rotational speed (1000 to 18,000 rev/min). The worktable machine consisted of six adjustable beams with suckers for mounting

Table 1. Wood composites selected to test (Rogoziński et al 2015).

Type of wood composite		Density (kg/m ³)	Thickness (mm)	Assigned letter
Layered boards	Compreg	1340	20	A
	Transformer plywood Elkon	990	20	B
	Plywood	660	18	C
	Exterior plywood with phenol film	730	12	D
	Blockboard	590	18	E
Made of chips	Chipboard	740	18	F
	Laminated chipboard	670	18	G
	Multifunctional panel	730	18	H
	Oriented strand board	595	18	I
Made of fibers	MDF	750	16	J
	Laminated MDF	760	16	K
	HDF	860	3	L
	One-side lacquered HDF	800	3	M
	Standard hardboard	950	5	N
	Porous fibreboard	235	12	O

HDF, high-density fibreboard; MDF, medium density fibreboard.

work pieces. Experimental milling was performed at the rotational speed of the tool of 18,000 rev/min (cutting speed 36.8 m/s) and the feed per revolution was 0.15 mm/rev. The cutting parameters established for the experiment were based on the recommendations of the tool producer (FABA S.A., Poland). The tool used for milling was a single point cutter head with diameter of 40 mm. The cutter head is shown in Fig 1. The geometric parameters of the cutting edge: clearance angle 10°, edge angle 55°, and rake angle 25°. The cutting edge was made of a cemented carbide signed KRC08 (Fig 2).

The experiment was performed in the same way as described by Rogoziński et al (2015) to ensure the comparability of the results. Air conditions in the lab were established on the levels: air RH 65% and temperature 22°C. The machining was

carried out as with the chip extraction system turned off due to the expected ineffectiveness of the extraction of the smallest dust particles. Therefore, the working zone was surrounded in a possibly tight manner by insulation foil, which prevented the escape of airborne dust particles outside the zone. The milling was carried out to achieve approximately 1000 g of dust. After the completion of milling, there was a 1-h delay established by use of clock of a computer integrated with the machine that allowed the airborne dust to settle. Finally, the entire zone was carefully cleaned with use of a vacuum cleaner connected with a measuring filter to collect the dust created during the experiment.

Particle-Size Analysis

Determination of the dust fractions with sizes of 0.08-1, 1-2.5, and 2.5-10 µm in the entire mass of chips created during milling was done by the proven methods. Sieve analysis using the sieve machine AS 200 Digit (Retsch, Hann, Germany) with a set of sieves with aperture sizes of 1000, 500, 250, 125, 63, and 32 µm, laser diffraction method using the Laser Particle Sizer Analysette 22 MicroTec plus (Fritsch, Germany) with measuring range of 0.8-2000 µm and calculation procedure of the mass fractions of dust of assumed ranges were

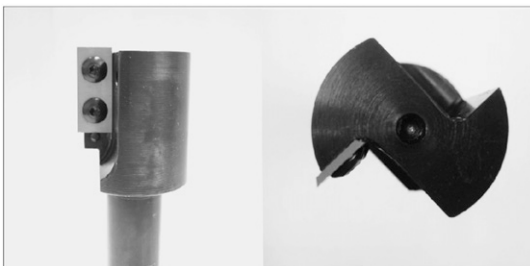

Figure 1. Cutter head.

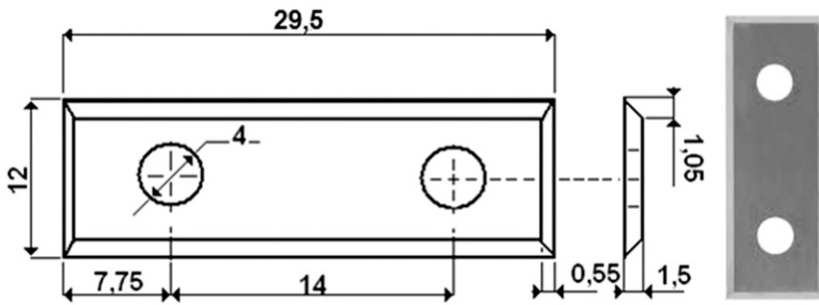

Figure 2. Geometry of the cutting edge.

particularly described and illustrated by Rogoziński et al (2015). In this way, it was also possible to compare the results obtained

using the same wood composites but different machining methods performed on the same machine.

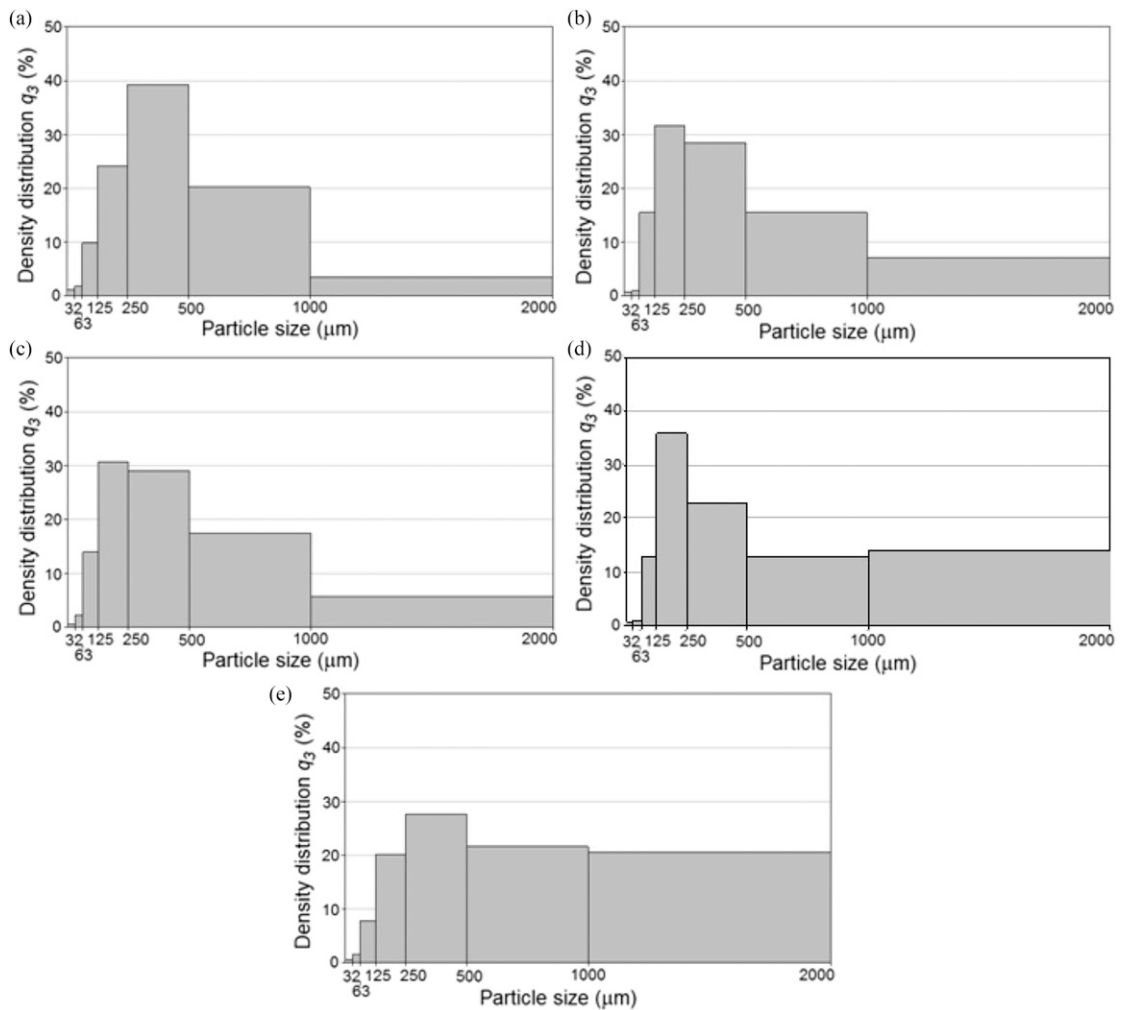

Figure 3. Particle-size distribution of dust from milling of layered boards obtained by sieve analysis.

The calculations of dust fraction in the ranges 0.08-1, 1-2.5, and 2.5-10 μm were done as follows:

$$C_i = C_{s32} \times C_{Li}$$

where C_i , dust fraction in the assumed size range of the whole mass of waste created,

C_{s32} , dust fraction isolated during the sieve analysis in the bottom collector,

C_{Li} , mass fractions of the dust in the assumed ranges determined using laser diffraction analysis in the C_{s32} fraction.

RESULTS AND DISCUSSION

Figures 3-5 show the results of the analysis of particle-size distribution obtained by the sieving method separately for three groups of types of wood composites. The particle size of dust created during milling depends on the type of wood composites. The content of the finest particles for layered boards was always very small. For the layered boards the fraction of particles which passed through the sieve with size 0.063 μm was

much less than 5%. For composites made of chips this fraction is about 5%, but for composites made of fibers this fraction is distinctly the biggest excluding standard hardboard and porous fibreboard, which are the wet-formed fibreboards. Milling of dry-formed fibreboards is a source of large amount of fine dust particles which may be airborne particles and disperse in the air inside the production room.

These results clearly illustrate the influence of the fragmentation degree of the wood used in the production of the composites on the particle-size distribution of dust created at processing. Dust particles created at milling of wood composites are smaller in comparison with drilling (Rogozński et al 2015). It is connected with a much higher rotational speed of tool usually used at milling.

Table 2 presents the results of the determination of the content of particles smaller than 10 μm in three-dimensional ranges with upper limits 1, 2.5, and 10 μm obtained by the laser diffraction method using Laser Particle Sizer Analysette

F3
F4
F5

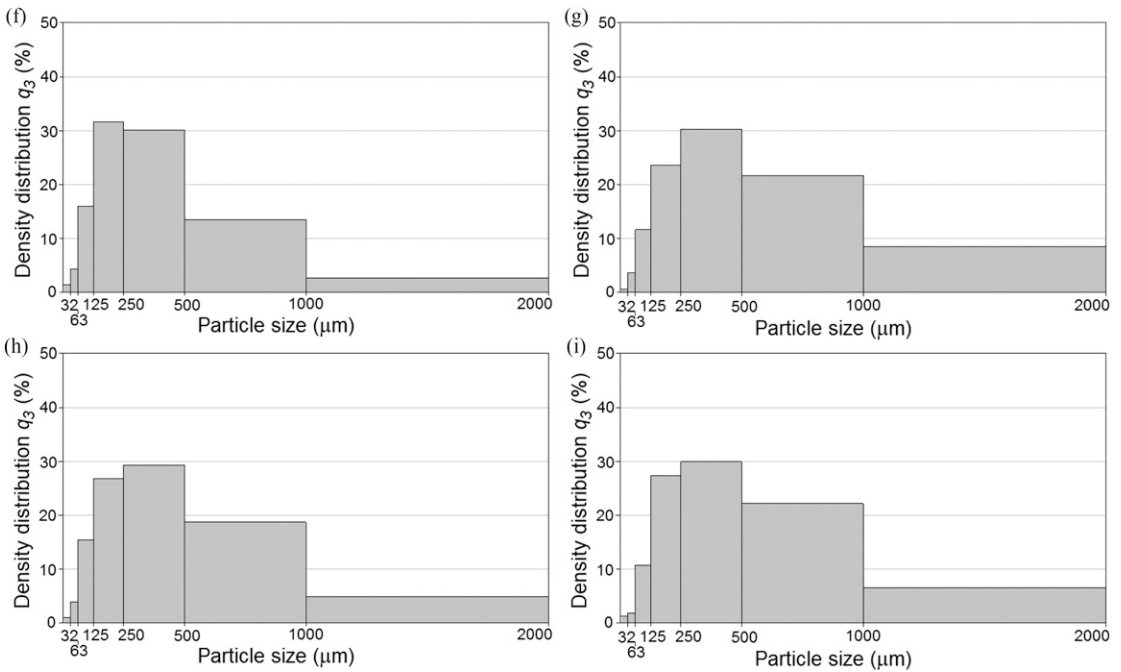

Figure 4. Particle-size distribution of dust from milling of wood composites made of chips obtained by sieve analysis.

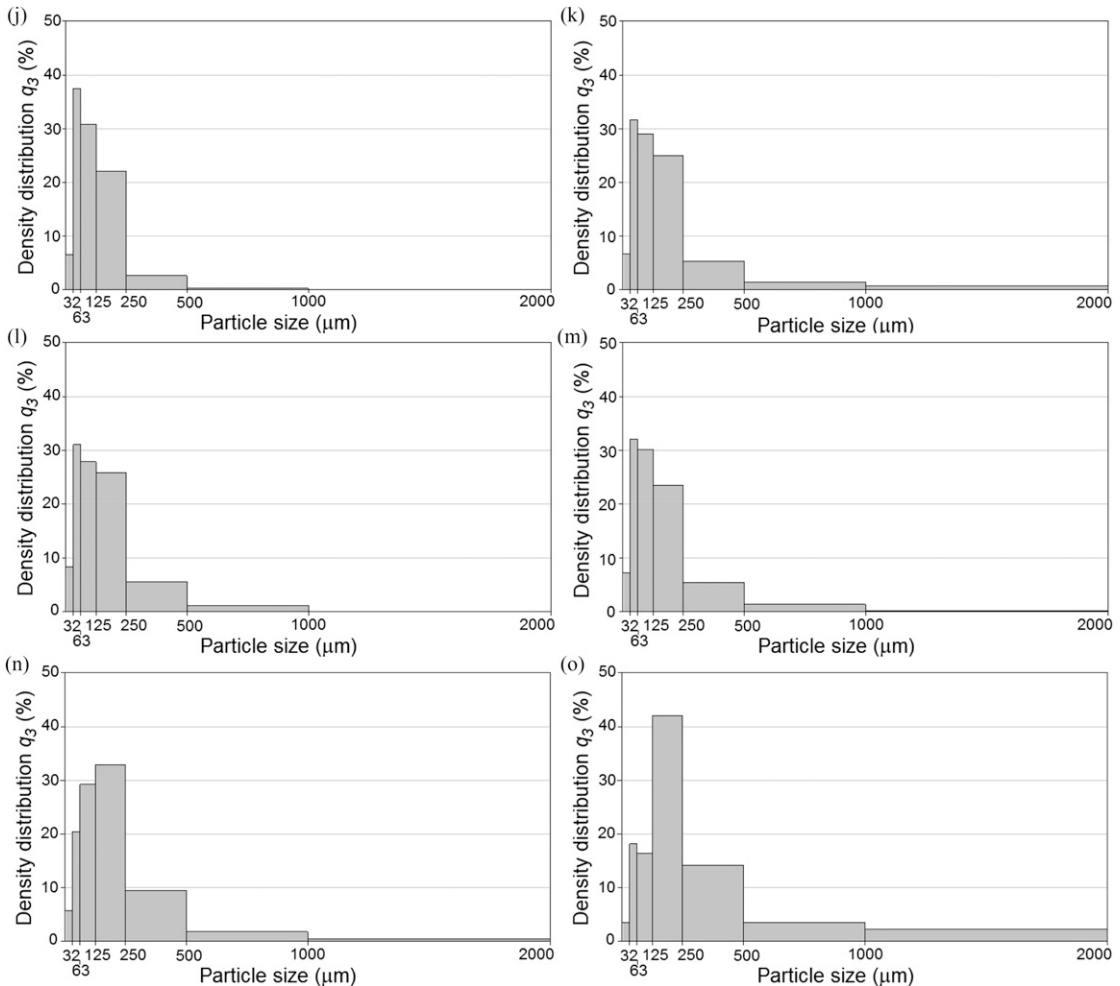

Figure 5. Particle-size distribution of dust from milling of wood composites made of fibers obtained by sieve analysis.

22 MicroTec plus (Fritsch, Germany). It was decided not to present the histograms and curves of distributions of tested dusts, because visually they do not differ much from each other. The analysis was done for the same fraction of all dusts. It was the finest dust collected in the bottom of the sieve set. Therefore, presentation of results in this way is more legible, and shows this part of the results which was taken for the calculation of the content of the finest dust particles in the assumed dimensional ranges. The final outcome of the experiments expressed as results from this calculation are shown in Figs 6-8. These results refer to the percentages of particles with the dimensions of 0.08-1, 1-2.5,

and 2.5-10 μm out of the whole mass of dust created in milling of the selected wood composites. It is easy to notice a big difference between the content of ultrafine particles in the dust formed during the milling of boards made of defibrated wood (except porous fibreboard) and other types of wood composites. For both types of medium-density fibreboard (MDF) and for standard hardboard the content of these particles is about 10 times higher than for the rest of the materials examined.

Milling of most of examined wood composites is a source of about two to three times bigger fractions of the smallest dust particles compared

Table 2. Content of the finest particles in dust which passed through the sieve with the aperture size of 32 μm (C_{Li}).

Upper limit of the range (μm)	Type of wood composite				
	A	B	C	D	E
	(%)				
1.00	0.005644	0.007552	0.006004	0.007503	0.011523
2.50	0.007183	0.008118	0.010164	0.009504	0.014709
10.00	0.010053	0.025582	0.028902	0.038499	0.051369

Upper limit of the range (μm)	Type of wood composite			
	F	G	H	I
	(%)			
1.00	0.013131	0.012176	0.008792	0.017783
2.50	0.018379	0.015187	0.011748	0.024010
10.00	0.061151	0.074452	0.023996	0.068306

Upper limit of the range (μm)	Type of wood composite					
	J	K	L	M	N	O
	(%)					
1.00	0.109731	0.110313	0.064182	0.026223	0.121889	0.002034
2.50	0.131675	0.128455	0.073834	0.026225	0.161043	0.002034
10.00	0.587573	0.721741	0.298034	0.043687	0.968922	0.002886

with the drilling done using the same machine. Only two composites signed A and O gave a smaller amount of fine dust during milling than drilling. Paradoxically, these were materials of the highest and lowest density of all included in the study. However, the overall trend is manifested by the creation of more finest particles during milling. This trend is particularly clearly visible for fibreboards MDF and high-density fibreboard (HDF).

The effect of the processing method and its parameters on the size of the produced chips was highlighted in this way. The feed per revolution was maintained in both experiments at the same level, but the rotational speed of tools was three times higher during milling according to the technical requirements of the manufacturers of the tools. This resulted in general increase in the amount of the finest particles which can be respirable when

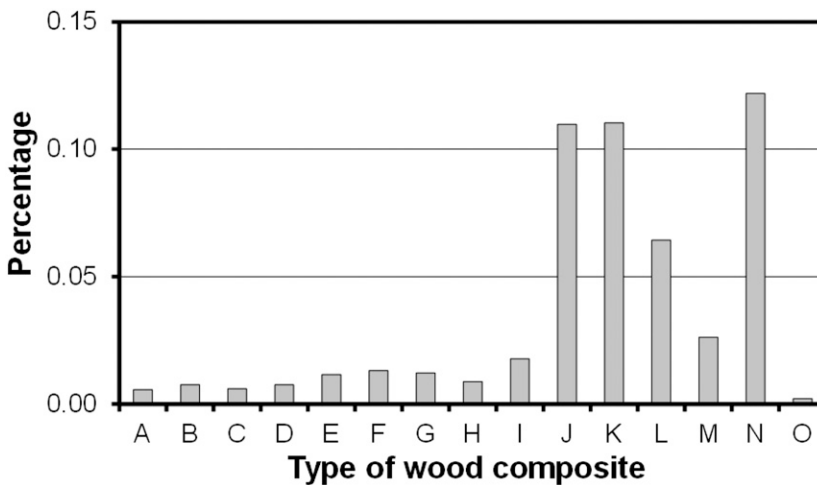

Figure 6. Content percentages of dust particles with a size smaller than 1 μm in the dust created during the milling of wood composites (C₁μm).

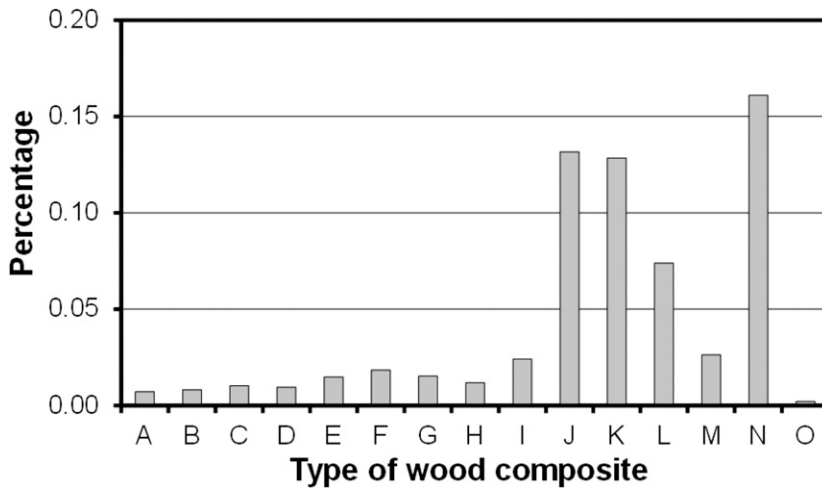

Figure 7. Content percentages of dust particles with a size of 1-2.5 μm in the dust created during the milling of wood composites ($C_i = 1-2,5 \mu\text{m}$).

dispersed in the air surrounding the work station equipped with the CNC woodworking machine.

CONCLUSIONS

Chips with a significant size differentiation are created in CNC milling of wood composites. Sieving analysis showed that the smallest chips and the finest dust are created during milling of fiberboards, in particular MDF and HDF. In case of other composites chips have significantly larger dimensions. It can be noted that milling of layered

boards creates chips with the finest fraction smaller than milling of particleboards. So there is a certain, difficult to quantify, relationship between the fragmentation degree of wood used to manufacturing the different wood composites. Milling of different wood composites conducted under the same cutting conditions is a source of dust with completely different particle sizes. This applies only to the assumed experimental conditions, because the use of different machines, tools, and parameters can also influence the dust generation.

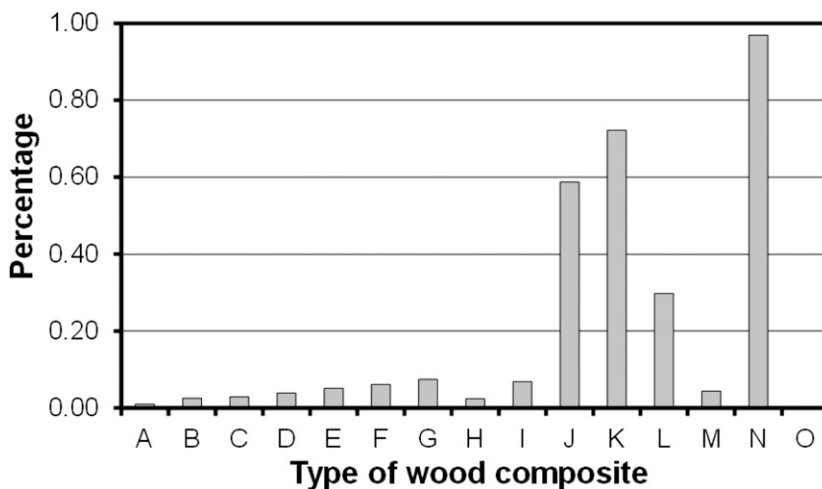

Figure 8. Content percentages of dust particles with a size of 2.5 to 10 μm in the dust created during the milling of wood composites ($C_i = 2,5-10 \mu\text{m}$).

Machining of wood composites at high levels of rotational speed of tools can be a reason of the risk of air pollution by very fine particles. It was found that the dust created in CNC milling contains particles with size smaller than 10 which can penetrate human respiratory tract down to its unciliated parts.

Experiments conducted on 15 types of most common wood composites and comparison of their results has shown that dust created during milling is more reduced in size than dust created during drilling performed on the same CNC machine. However, there are two exceptions. There is also the general trend to increased amount of finest particles in dust created in milling than in dust created in drilling of the same wood composites. This trend is more significant for composites made of defibrated wood.

Machining of different types of wood composites should require a proper selection of cutting parameters taking into account purity of air in the workplace.

ACKNOWLEDGMENT

This work was supported by Polish Ministry of Science and Higher Education (Project No NN309007537).

REFERENCES

- Beljo-Lučić R, Čavlović AO, Jug M (2011) Definitions and relation of airborne wood dust fractions, *Woodworking Techniques*. Pages 25-32. Proc. 4th International Scientific Conference. Edited by: Barcik S, Dvorak J, Czech University of Life Sciences, Prague.
- Dzurenda L, Orłowski K, Grzeskiewicz M (2010) Effect of thermal modification of oak wood on sawdust granularity. *Drv Ind* 61(2):89-94.
- Fujimoto K, Takano T, Okumura S (2011) Difference in mass concentration of airborne dust during circular sawing of five wood-based materials. *J Wood Sci* 57(2):149-154.
- Kauppinen T, Vincent R, Liukkonen T, Grzebyk M, Kauppinen A, Welling I, Arezes P, Black N, Bochmann F, Campelo F, Costa M, Elsigan G, Goerens R, Kikemenis A, Kromhout H, Miguel S, Mirabelli D, McEneaney R, Pesch B, Plato N, Schlünssen V, Schulze J, Sonntag R, Verougstraete V, De Vicente MA, Wolf J, Zimmermann M, Husgafvel-Pursiainen K, Savolainen K (2006) Occupational exposure to inhalable wood dust in the member states of the European Union. *Ann Occup Hyg* 50(6):549-561.
- Kos A, Beljo-Lučić R, Šega K, Rapp AO (2004) Influence of woodworking machine cutting parameters on the surrounding air dustiness. *Holz Roh-Werkst* 62(3):169-176.
- Mračková E, Křišťák L, Kučerka M, Gaff M, Gajtanska M (2015) Creation of wood dust during wood processing: Size analysis, dust separation, and occupational health. *BioResources* 11(1):209-222.
- Očkajova A, Beljakova A, Siklienka M (2010) Morphology of dust particles from the sanding process of the chosen tree species. *Wood Res* 55(2):89-98.
- Paľubicki B, Rogoziński T (2016) Efficiency of chips removal during CNC machining of particleboard. *Wood Res* 61(5):811-818.
- Prekrat S, Pervan S, Smardzewski J, Stjepan T, Jasna H (2009) Determination of furniture quality criteria in the projecting stage. Pages 113-118 in I Grbac, ed. *Wood is good—new materials, quality and design of products*, University of Zagreb, Zagreb, Croatia.
- Rautio S, Hynynen P, Welling I, Hemmilä P, Usenius A, Närhi P (2007) Modelling of airborne dust emissions in CNC MDF milling. *Holz Roh-Werkst* 65(5):335-341.
- Rogoziński T, Wilkowski J, Górski J, Czarniak P, Podziewski P, Szymanowski K (2015) Dust creation in CNC drilling of wood composites. *BioResources* 10(2):3657-3665.
- Varga M, Csanady E, Nemeth G, Nemeth S (2006) Aerodynamic assessment of the extraction attachment of CNC processing machinery. *Wood Res* 51(2):49-62.